

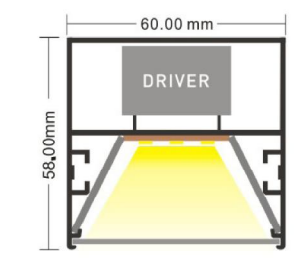

Ceiling

Pendant

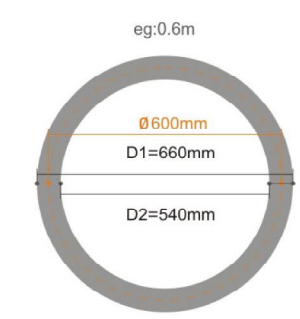

Diameter Ø/m	Power /w	Lumens /lm
0.6	38	3391
1.0	63	5652
1.2	75	6782
1.5	94	8478
2.0	126	11304
2.4	151	13564
3.0	188	16956
5.0	314	28260

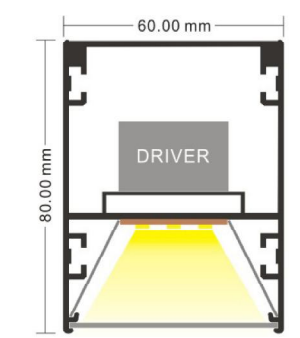
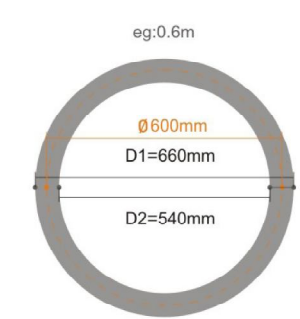
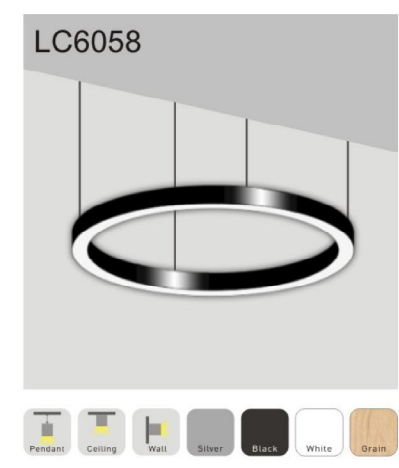

Diameter Ø/m	Power /w	Lumens /lm
0.6	38	3391
1.0	63	5652
1.2	75	6782
1.5	94	8478
2.0	126	11304
2.4	151	13564
3.0	188	16956
5.0	314	28260

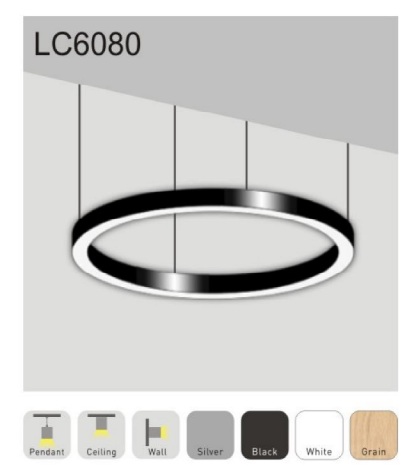

On/Off PWM 0/1-10V DALI

Parameter Remark

Electrical Parameters	Optical Parameters	Structure Parameters
Power tolerance: ±1.5W	Lumens tolerance: ±150lm	Length tolerance: ±2mm
Input voltage: 220-240VAC ( 100-277 )	CCT: 2400-6500K ( RGB )	Material: 6063-T5 / PC
Frequency: 50/60 Hz	CRI: >80 / >93	Dimming: No ( DALI/0-10V/PWM )
Efficiency: >85%	Efficiency: >85%	Product color: Silver/White/Black/Grain
Power Factor: PF>0.95	Efficacy: >90 lm/W	Driver installation: Internal
Flicker: No flicker	Chip brand: CREE/NICHIA/OSRAM/Sanan	Warranty: 5 Years
Driver certificate: CE/ TUV/ SAA/ UL	LED type: SMD2835/SMD5730/SMD5050	
Driver brand: PHILIPS/TRIDONIC/AGT	Lifespan: 50,000hs	

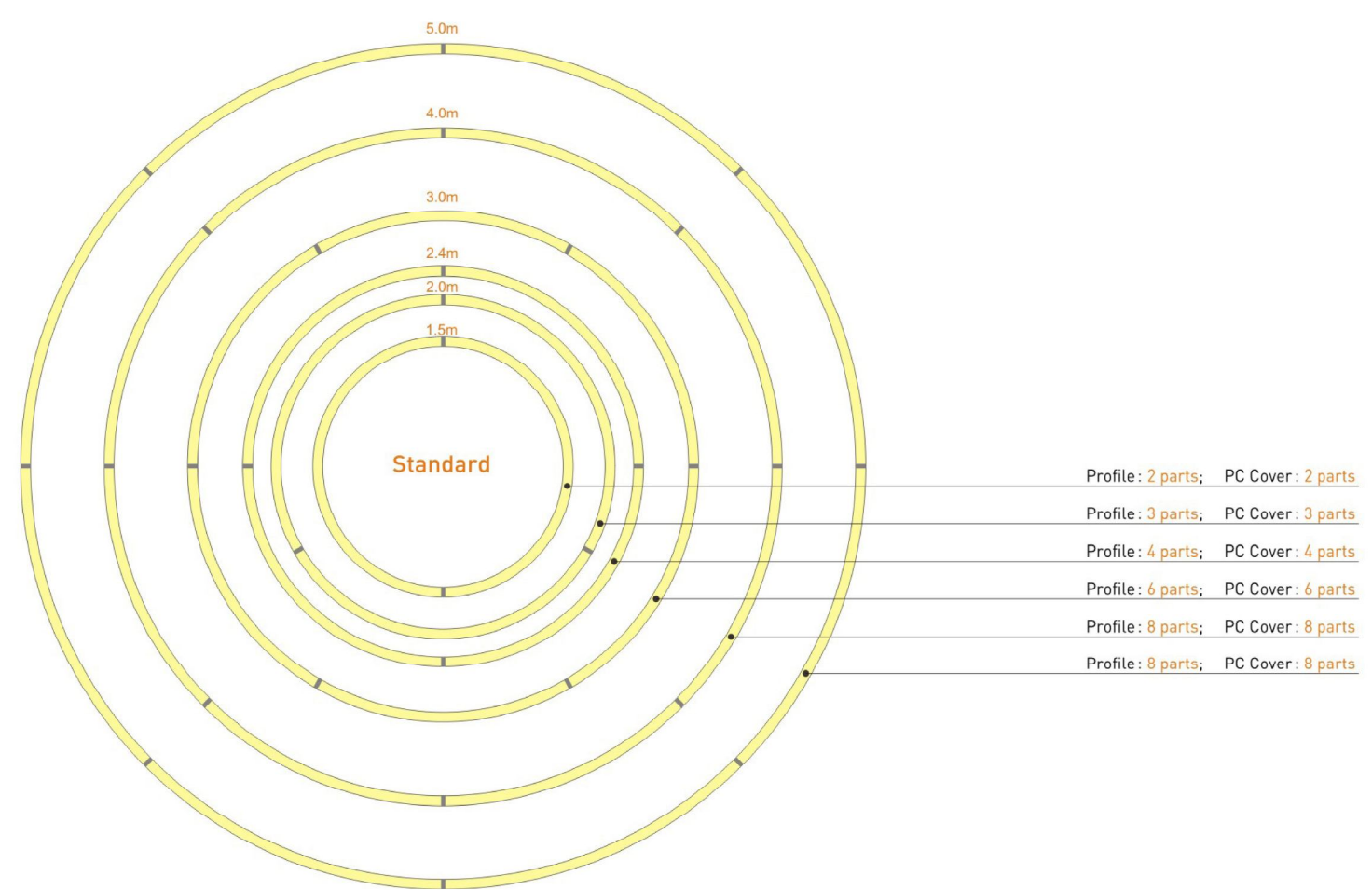
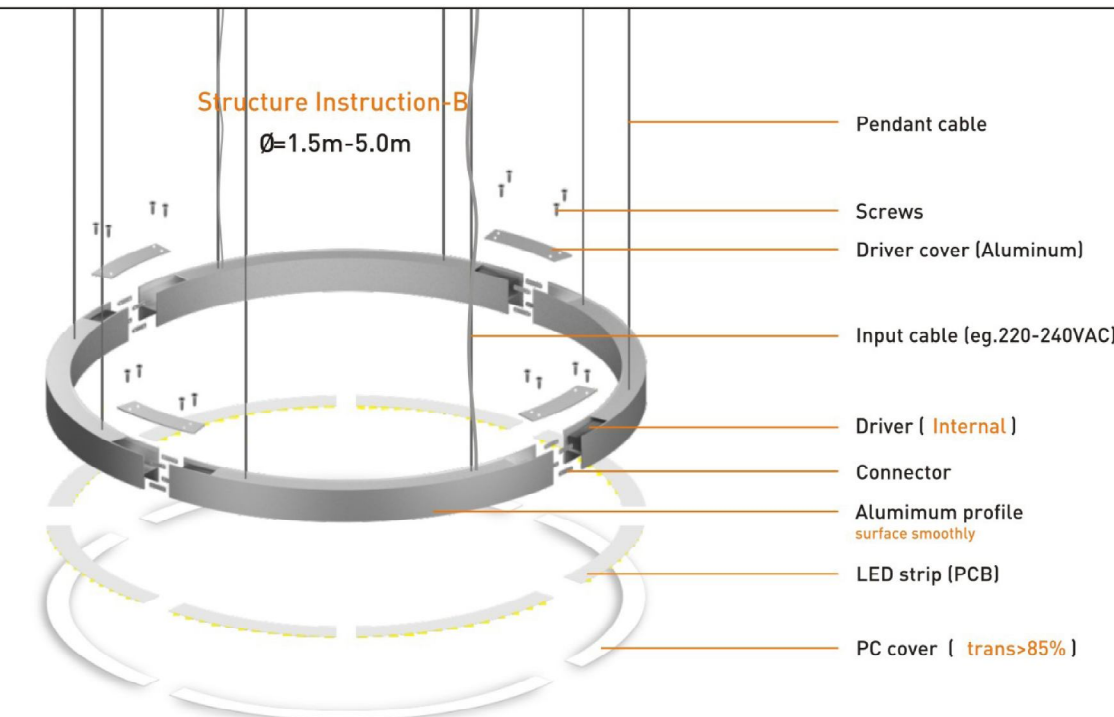
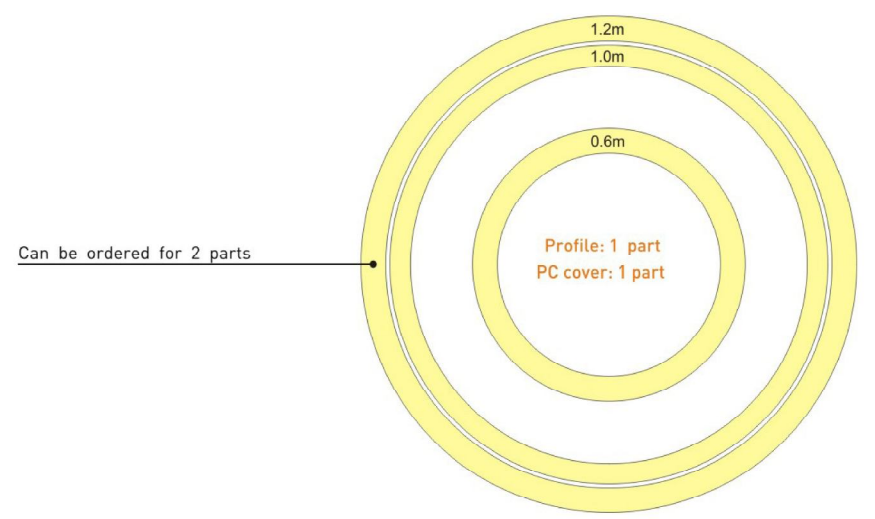
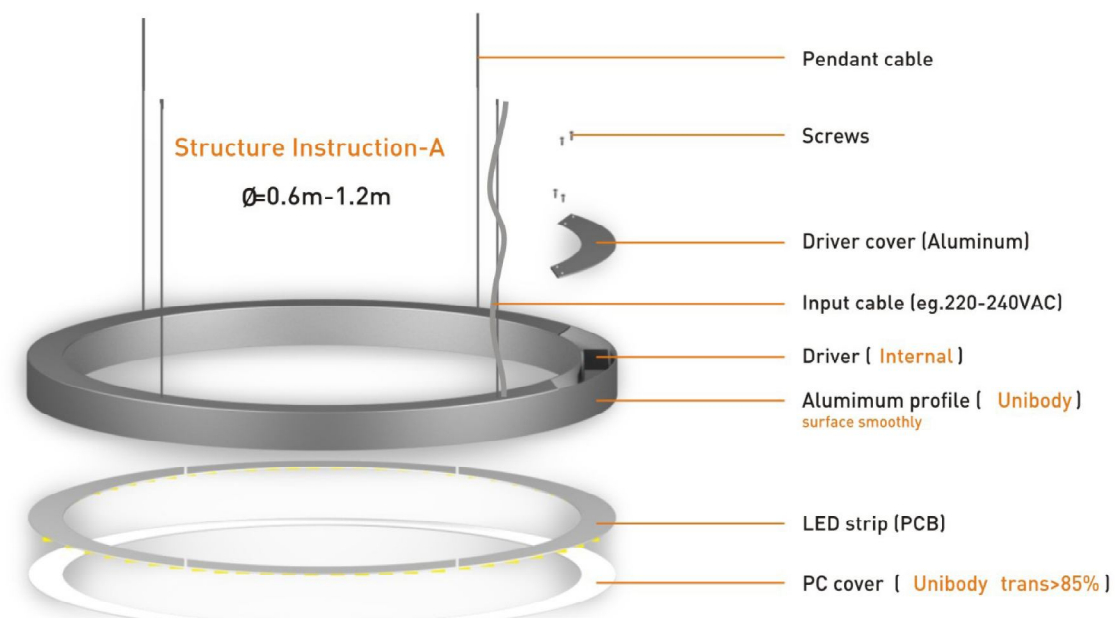

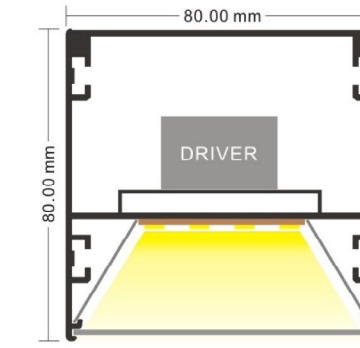
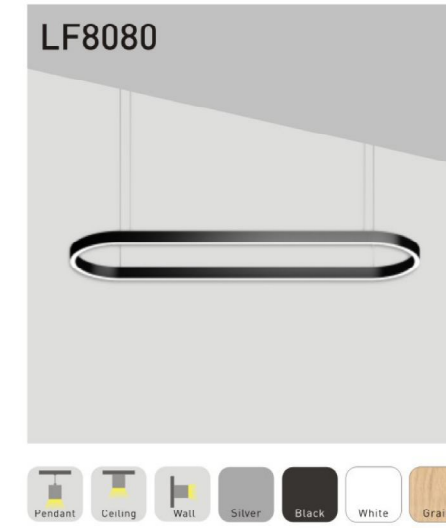
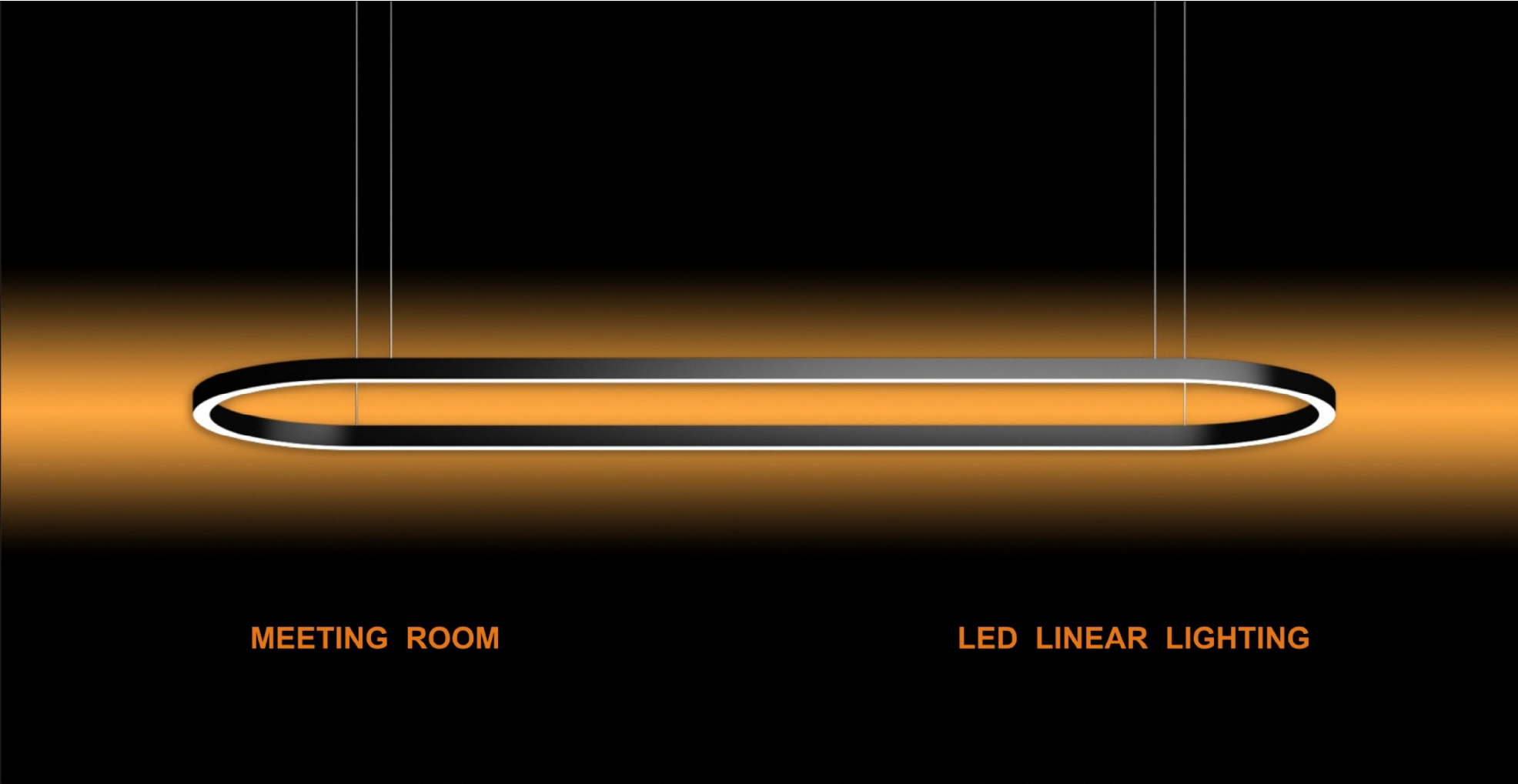

Length /m	Power /w	Lumens /lm
2.0	160	14400
3.0	220	19800
4.0	280	25200
5.0	340	30600
6.0	400	36000
7.0	460	41400



**Structure Instruction**

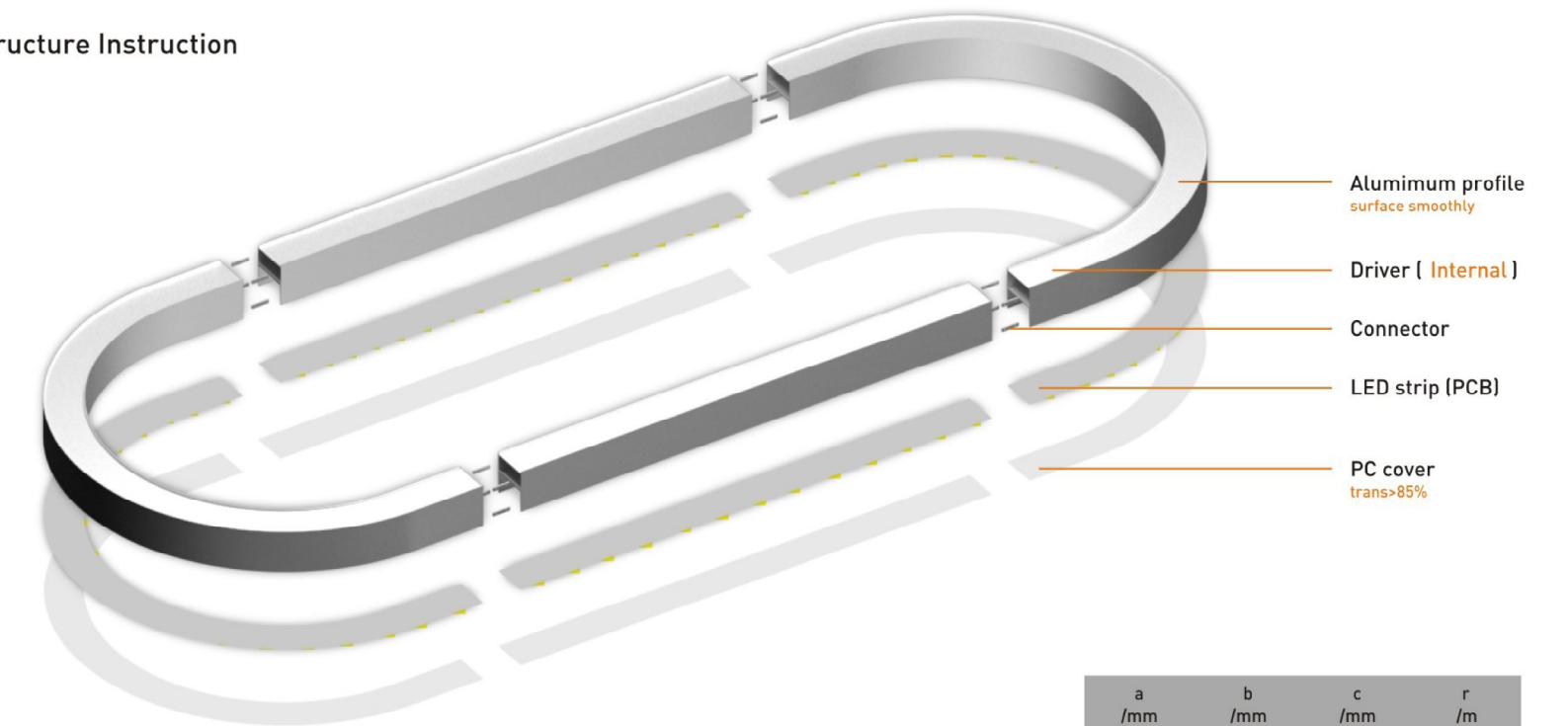

a /mm	b /mm	c /mm	r /m
40			0.3
50			0.5
60			0.6
70	200	Customized	0.75
80			1.0
90			1.2
100			1.5
120			2.5

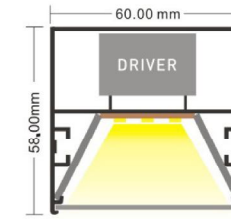
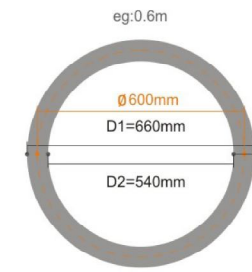

Diameter Ø/m	Power /w	Lumens /lm
0.6	38	3391
1.0	63	5652
1.2	75	6782
1.5	94	8478
2.0	126	11304
2.4	151	13564
3.0	188	16956
5.0	314	28260

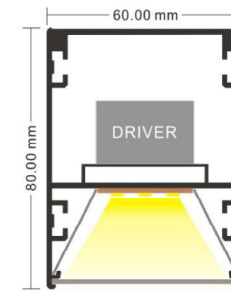
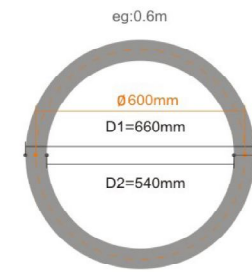
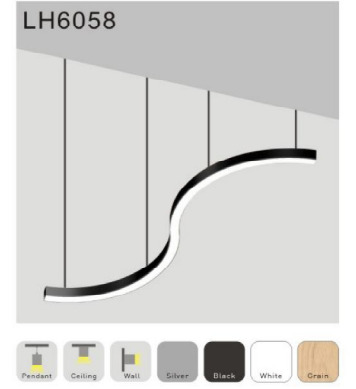

Diameter Ø/m	Power /w	Lumens /lm
0.6	38	3391
1.0	63	5652
1.2	75	6782
1.5	94	8478
2.0	126	11304
2.4	151	13564
3.0	188	16956
5.0	314	28260

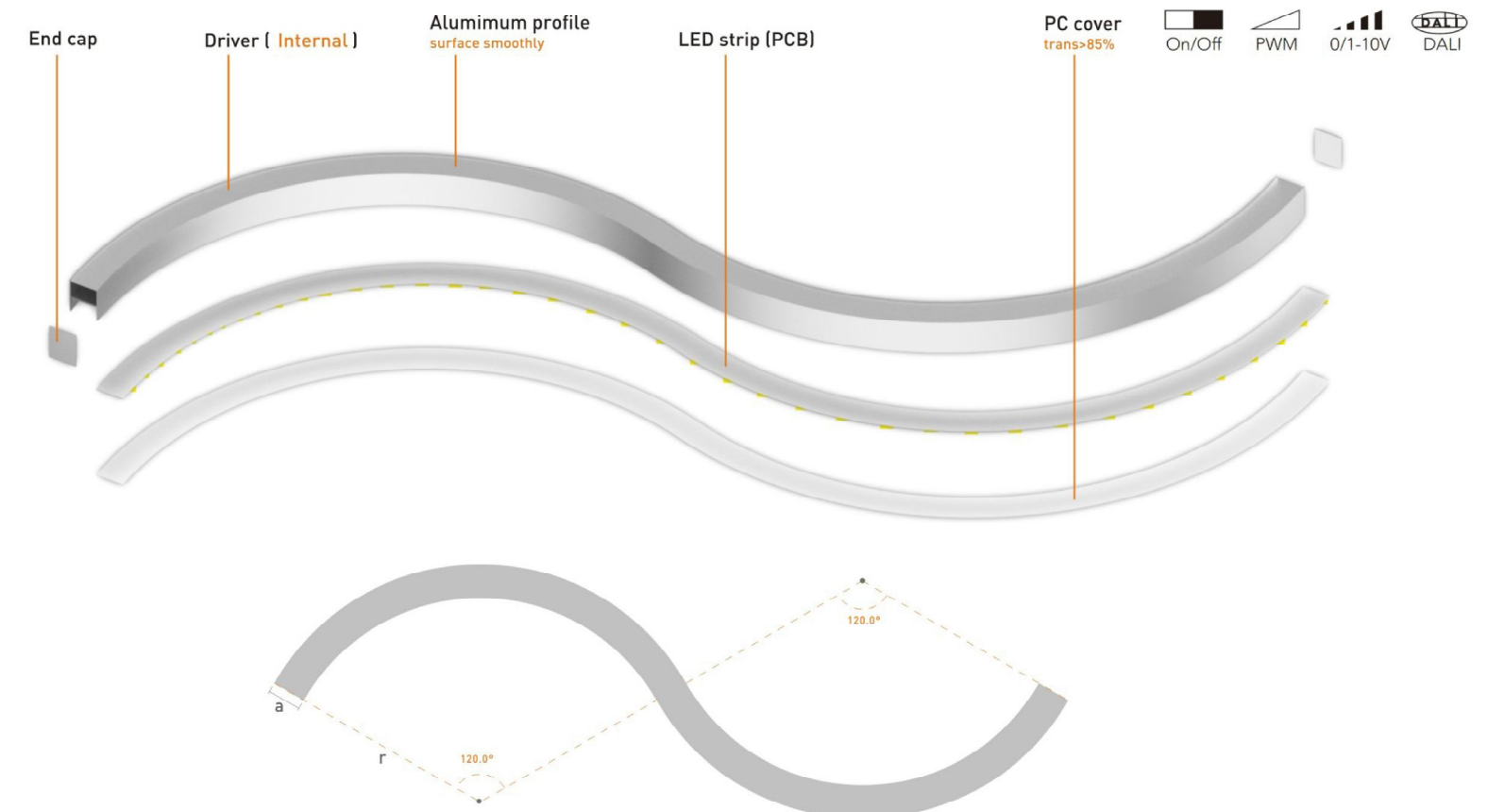
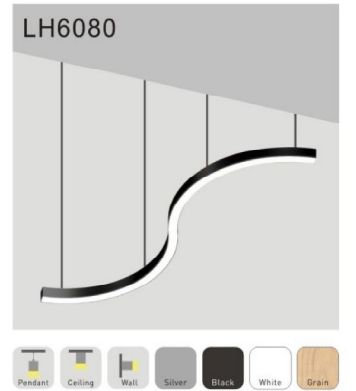

eg

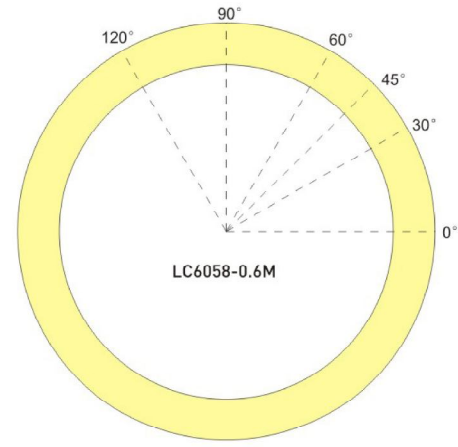

### Standard List

P6058-L0.5M



P6058-L1.0M



P6058-0.6M-30

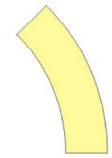

P6058-0.6M-45

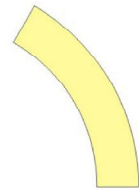

P6058-0.6M-60

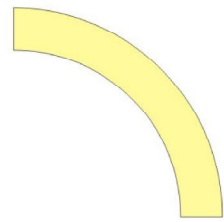

P6058-0.6M-90

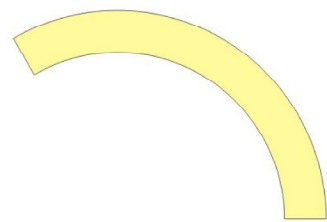

P6058-0.6M-120

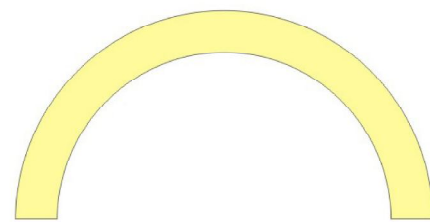

P6058-0.6M-180

### FREE YOUR DESIGN

CASE 1: 90 degree + Line

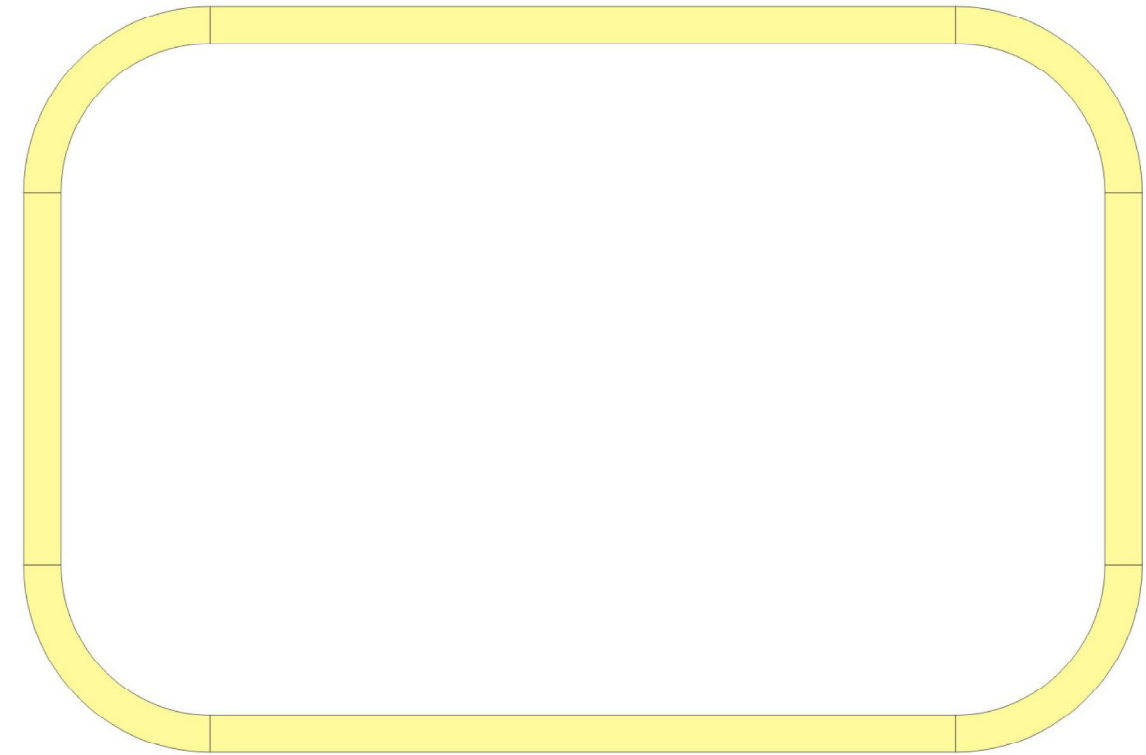

CASE 2: 120 degree + 120 degree

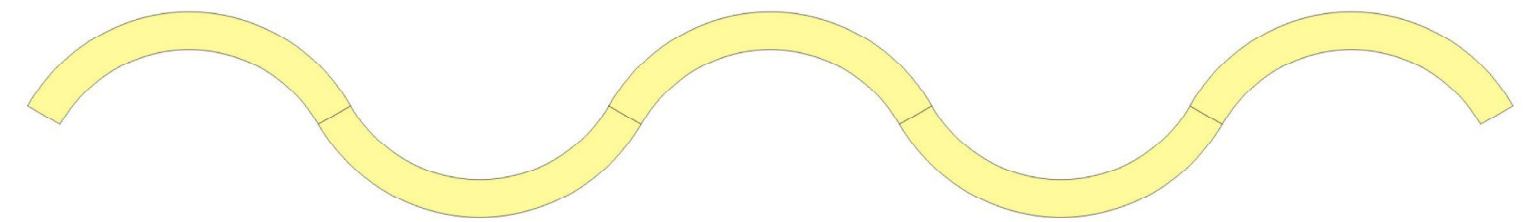

CASE 3: 60 degree + 90 degree

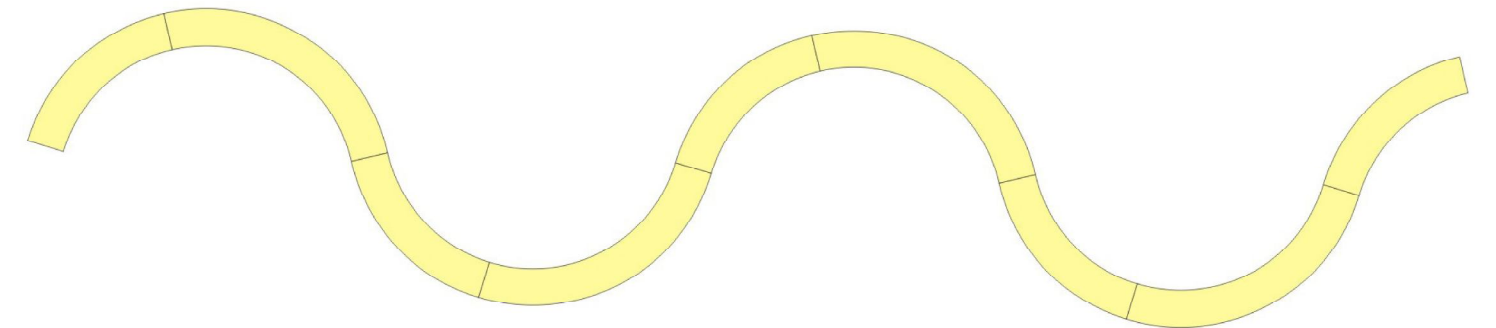

## FREE YOUR DESIGN

CASE 4: 180 degree + Line



CASE 5: 30 degree + 60 degree + 90 degree

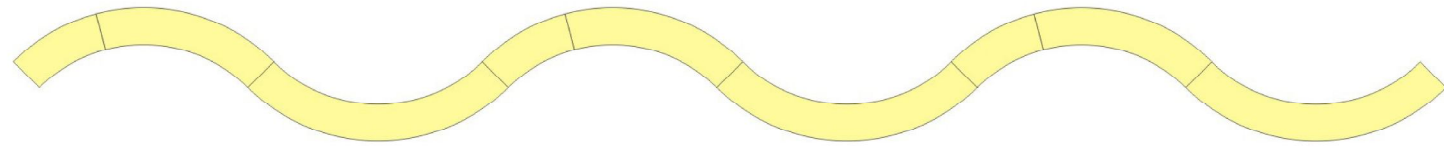

CASE 6: 30 degree + 120 degree + Line

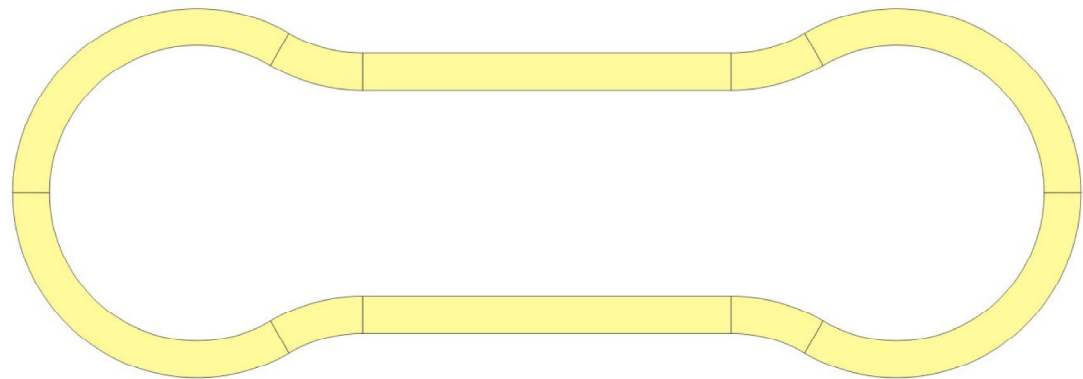

CASE 7: 30 degree + 45 degree + 60 degree + 90 degree + 120 degree + 180 degree + Line

